



NF5180M6 White Paper

Version 1.0

Date 2021/6/28

Dear customers:

Copyright © 2021 Inspur Group Co., Ltd. All Rights Reserved.

No part of this document may be reproduced, modified or transmitted in any form or by any means without prior written consent of Inspur.

Note: The products, services, and features you purchase shall be subject to the commercial contracts and terms of Inspur Group. All or part of the products, services, and features described in this document may not be within the purchase scope or the usage scope. Unless otherwise specified in the contract, all information in this document is provided "AS IS" without warranties, guarantees, or representations of any kind, either express or implied. The information in this document is subject to change without notice. Unless otherwise agreed, this document serves as a user manual only. All statements, information, and recommendations in this document do not constitute the warranty of any kind, express or implied.

Inspur and Inspur Logos are registered trademarks of Inspur Group.

Windows is a registered trademark of Microsoft Corporation.

Intel and Intel Xeon are registered trademarks of Intel Corporation.

All other trademarks are the property of their respective owners.

Technical Support:	1-844-860-0011/1-760-769-1847
Address:	No. 1036, Langchao Road, Jinan, Shandong Province, China Inspur Electronic Information Industry Co., Ltd.
Postal Code:	250101

Change History

Date	Version	Drafted/ Revised By	Reviewed By	Approved By	Revisions
2021/06/28	V1.0	Bily liu	Vicky Liu	Kevin Liu	

Table of Contents

Change History.....	ii
1 Product Overview	7
2 Features.....	8
3 New Technical Points.....	9
3.1 Intel Scalable Architecture	9
3.2 Intel VROC	9
3.3 OCP 3.0 Module	9
3.4 E1.S SSD	9
3.5 Intel Optane™ Persistent Memory 200 Series	9
4 Logical Architecture.....	10
5 Product Overview	11
5.1 Front Panel.....	11
5.1.1 4 × 3.5" + 2 × E1.S + 2 × M.2 Front Panel	11
5.1.2 4 × 3.5" + 4 × 2.5" Front Panel.....	11
5.1.3 10 × 2.5" Front Panel	12
5.1.4 8 × 2.5" + 2 × E1.S + 2 × M.2 + VGA Front Panel	12
5.1.5 12 × 2.5" Front Panel	12
5.1.6 32 × E1.S Front Panel	13
5.1.7 T-Shape Fanless Model Front Panel	13
5.1.8 2.5"/3.5" Drive Tray LED.....	14
5.2 Rear Panel.....	14
5.2.1 1 × PCIe + 2 × 2.5"	14
5.2.2 2 × PCIe.....	15
5.2.3 3 × PCIe	20
5.3 Internal Top View	16
5.4 OCP3.0 Module	18
5.5 M.2 SSD Module	18
5.6 X4 M.2 Module	18
5.7 2 X M.2 SSD+2 X E1.S SSD	18
5.8 Mainboard Layout.....	20
5.9 Mainboard Differences	21
5.10 Relationship Between Front and Rear Windows	21
6 System Specifications.....	23
7 Compatibility List	28
7.1 Processor	28

7.2	Memory	29
7.3	Storage	40
7.3.1	SATA/SAS Drive Model.....	40
7.3.2	U.2 NVMe SSD	40
7.4	Drive Backplane	41
7.5	Drive Installation Position.....	33
7.5.1	Drive Installation Sequence.....	33
7.6	RAID/SAS Card.....	34
7.7	NIC.....	35
7.8	HCA Card	36
7.9	Graphic Card	36
7.10	Power Supply	36
7.11	Operating System	37
8	Configuration Notes	39
9	System Management.....	40
9.1	Intelligent Management System BMC.....	40
9.2	Inspur Physical Infrastructure Manager (ISPIM)	42
9.3	Inspur Server Intelligent Boot (ISIB).....	43
10	Certification.....	45
11	Support and Services	46
12	Relevant Documents.....	47
13	Trademark.....	59

1 Product Overview

Inspur NF5180M6 is a 1U 2-socket rack-mounted server for high-density computing purposes. With the Xeon® Scalable processor design from the Intel® Whitley platform, it maximizes the performance, density, and scalability of the server and adapts to computing-intensive services such as virtualization, high-performance computing, and online computing, meeting the deployment requirements of high-density data centers.

2 Features

Inspur NF5180M6 delivers high quality and reliability for all kinds of applications, as Inspur servers always do. It features highly flexible configurations to cater to mainstream market demands, providing extreme performance, scalability, availability, and manageability at the same time.

Performance

- NF5180M6 is built on the new third-generation Intel® Xeon® Scalable processors. Each CPU supports up to 40 cores running at the maximum processor frequency of 3.6 GHz and up to 270 W thermal design power (TDP) with 3 Ultra Path Interconnect (UPI) links at 11.2 GT/s, enabling an increase in the overall computing performance by 40%.
- 32 3200 MT/s DDR4 ECC RDIMM memory modules with each having a maximum capacity of 128 G, adding up to 10 T to deliver a high read/write speed and high availability.
- 3200 MHz Optane® Persistent Memory (PMEM) with a maximum capacity of 512 G, using which data loss does not easily occur in case of power outage, while memory capacity and bandwidth are not even reduced.
- All-flash configuration of up to 12 hot-swap NVMe SSDs that provide a high input/output operations per second (IOPS) solution ten times better than that provided by high-end enterprise-level SATA SSDs, with the storage capacity increased by 20% compared to the previous generation.
- All-flash configuration of up to 32 hot-swap E1.S SSDs that inherit the advantages of traditional NVMe SSDs with a high IOPS and features a small footprint, implementing massive storage in 1U space and providing 3.2 times better overall IOPS performance.

Scalability

- Up to 12 front 2.5" SAS/SATA/NVMe drives and 2 rear 2.5" SAS/SATA drives or 32 front E1.S SSDs are supported.
- The OCP 3.0 module offers multiple options (1/10/25/40/100 G) to be flexibly applied in various network structures.
- Up to 3 standard PCIe 4.0 expansion slots (3 × PCIe x16) and customizable PCIe layouts are supported to meet different customer needs.
- M.2 or E1.S modules are optional in the front to support diversified storage requirements.
- 2 onboard SATA M.2 SSDs or 2 built-in PCIe X4 M.2 SSDs are allowed.

Availability

- With a user-friendly design, the entire system supports tool-free maintenance. With enhanced structural parts, it allows easy assembly/disassembly, greatly reducing the O&M time.
- The combination of Inspur-developed intelligent control technology and cutting-edge air cooling system provides the best working environment to ensure stable running of the system.
- Hot-swap drives can be configured to RAID level 0/1/10/5/6/60/1E, with RAID cache and super capacitor module for data protection in case of power outage.
- With the latest Baseboard Management Controller (BMC), it allows technicians to quickly locate component that has broken down (or is breaking down) through the Web GUI, fault diagnosis LEDs and UID LEDs on the front panel, simplifying maintenance, speeding up troubleshooting, and enhancing system availability.
- It monitors system parameters through the BMC and reports alarms in advance, so that technicians can take appropriate actions in a timely manner to ensure stable running of the system and minimize system downtime.

Manageability

- The server is equipped with Inspur Server Baseboard Management Controller (ISBMC), a remote server management system developed by Inspur.
- ISBMC supports mainstream management specifications in the industry, such as IPMI 2.0 and Redfish 1.8.
- ISBMC features high operational reliability.
- ISBMC features excellent maintainability for different scenarios.
- ISBMC provides comprehensive, precise fault diagnosis capabilities.
- ISBMC supports security reinforcement above the industry level.
- The ISPIM intelligent management software enables centralized management of servers, as well as full lifecycle management of servers covering unified part-level asset management, intelligent monitoring and alarming, automatic inspection, fault diagnosis and warranty, energy consumption management, and firmware upgrade/ configuration.
- The Inspur Server Intelligent Boot (ISIB) system enables rapid server initialization, batch RAID configuration and OS deployment.

Energy Efficiency

- 80 PLUS Platinum power supply unit (PSU) (550 W - 1300 W), with the efficiency reaching up to 94% at a load of 50%.
- 1+1 redundancy, and integrated AC/DC power supply for optimized power conversion efficiency.
- Efficient voltage regulator down (VRD) PSU to reduce the loss of DC-DC conversion.

- Intelligent speed control of fans and intelligent frequency modulation of CPUs for energy conservation.
- The RV performance of HDDs are improved by using exquisite heat dissipation design, optimized fan models, and honeycomb-style waveguide boards.
- With the introduction of the EVAC solution, 1U space now supports 2 270 W CPUs, enabling easy server deployment in high-density data centers.

Security

- In terms of hardware design, the mainboard and backplane are equipped with the overcurrent and overvoltage protection function, and the onboard connectors and cables are designed to be fool-proof, thus protecting against overload impacts.
- For structural security, a panel latch and top cover latch are added to for real-time warning of chassis intrusion.
- All physical I/O interfaces are clearly defined without any unclear interface reserved. An access control mechanism is built for the interfaces used for maintenance to prevent malicious operations by unauthorized personnel.
- Regarding firmware security, image files are signed using secure encryption algorithms before release, and the signature must be validated before firmware update, thus ensuring the integrity and legitimacy of the firmware.
- The ISBMC intelligent management system provides various security features such as identification and authentication, authorization and access control, Web security configuration, and log audit, and its security reinforcement capability is leading the industry.
- Optional Trusted Platform Module (TPM)/Trusted Cryptography Module (TCM) for data encryption and security to support secure boot of servers.

3

New Technical Points

3.1 Intel Scalable Architecture

The new generation Intel® Xeon® Scalable processors are built on the Ice Lake-SP architecture, where the chipset uses the new Mesh interconnection design instead of the traditional Ring design to reduce CPU access latency while providing higher memory bandwidth. Besides, with low power consumption, the processors can work at a low clock speed and at a low voltage, so as to better improve performance and energy efficiency. The new generation features an increase by 193% in AI training performance for image classification when compared with the previous generation.

3.2 Intel VROC

Intel® Virtual RAID on CPU (VROC) is specially designed for enterprise-level RAID solutions based on NVMe SSDs. Its biggest advantage lies in direct management of NVMe SSDs connected to PCIe channels of Intel® Xeon® Scalable processors, without the need for any RAID HBA.

3.3 OCP 3.0 Module

The optional OCP 3.0 NIC (up to 100 G) provides larger scalability.

3.4 E1.S SSD

E1.S SSDs inherit the advantages of traditional NVMe SSDs with a high IOPS and feature a small footprint, with each having a maximum capacity of 4 T. The maximum capacity of 1U system can be expanded to 128 T, greatly improving the storage density of the server in 1U space.

3.5 Intel Optane™ Persistent Memory 200 Series

Intel Optane™ Persistent Memory 200 series (BPS) is a new type of persistent memory module that enables persistent memory data storage even in case of power outage. In comparison with traditional NVDIMM, super capacitor modules are not needed, making it easy to configure the memory module into the system. The latest generation of Intel Optane™ Persistent Memory 200 Series DC non-volatile memory can greatly reduce power consumption from 18 W to 15 W with the highest speed increased to 3200 MT/s and a total memory capacity of up to 4 T in each socket. It also delivers an average of 25% more memory bandwidth than the previous generation.

4 Logical Architecture

NF5180M6 supports 2 Intel® Xeon® Scalable processors and 32 DDR4 DIMMs.

Data can be transferred between the two processors through 3 UPI buses at a maximum speed of 11.2 GT/s.

The processors are connected to the 3 PCIe slots on the board through the PCIe bus. Up to 2 PCIe Gen4 x16 full-height and half-length cards or 2 PCIe Gen4 x16 half-height and half-length cards and 1 PCIe Gen4 x16 full-height and half-length card are supported.

The onboard RAID card or X4 M.2 board connects to CPU0 through the PCIe bus and to the drive backplanes through SAS signal cables. The drive backplanes support various local storage configurations.

The following figure 4-1 illustrates the logic block diagram of NF5180M6.

Figure 4-1 Logic Block Diagram of NF5180M6

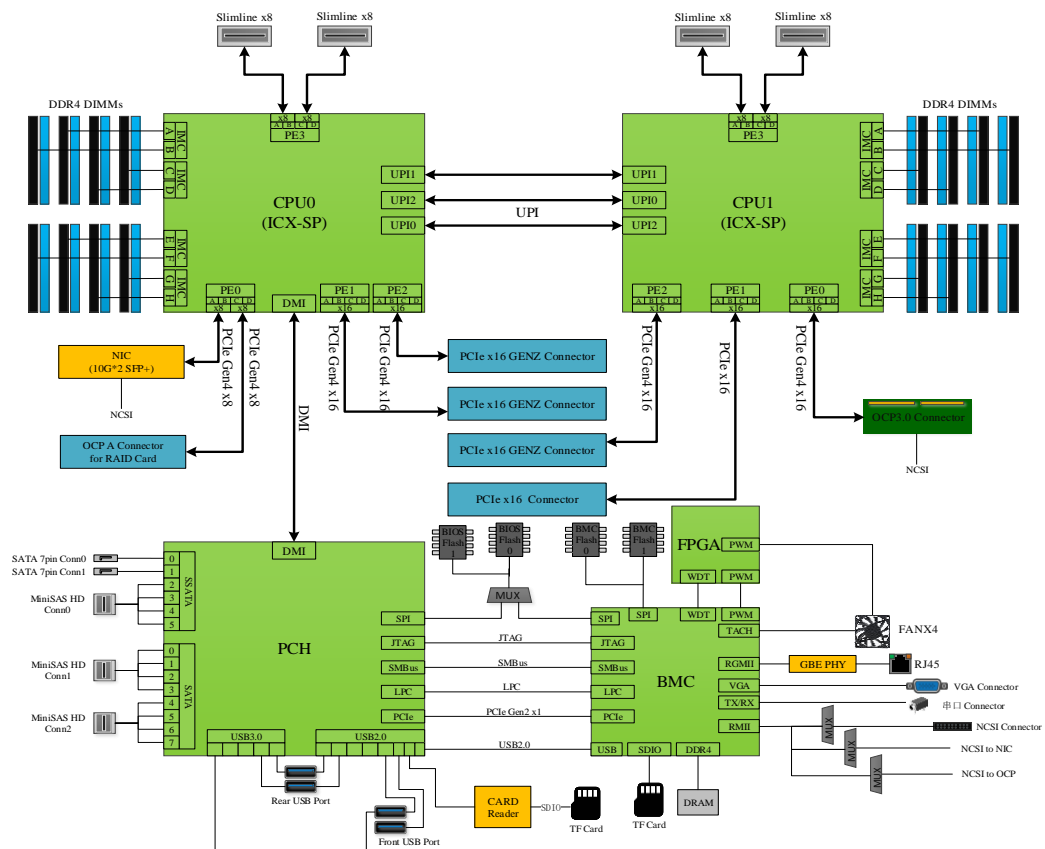

5 Product Overview

5.1 Front Panel

5.1.1 4 × 3.5” + 2 × E1.S SSD + 2 × M.2 SSD Front Panel

Figure 5-1 Front View

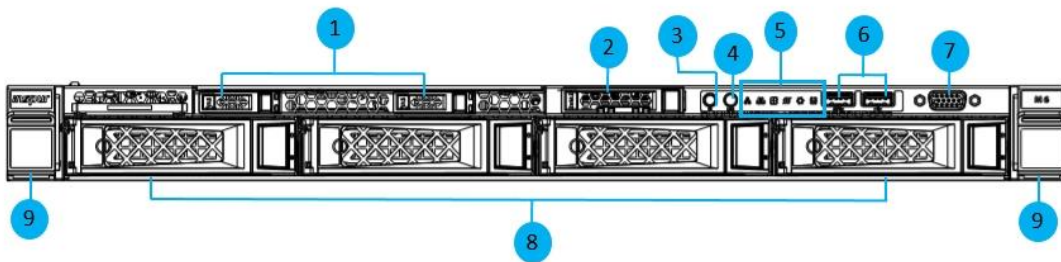

1	E1.S SSD	6	USB Ports: USB 3.0 (left) and USB 2.0 (right)
2	M.2 SSD	7	VGA Port
3	Power Button	8	3.5” Drive
4	UID/RST Button	9	Server and Chassis Latch
5	LED		

5.1.2 4 × 3.5” + 4 × 2.5” Front Panel

Figure 5-2 Front View

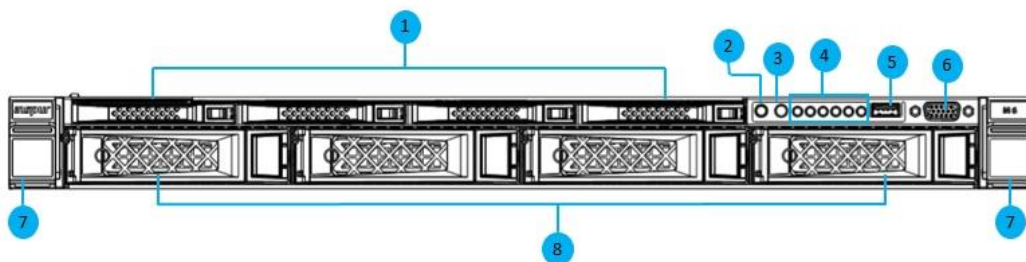

1	2.5” Drive Module	5	USB 3.0 Port
2	Power Button	6	VGA Port
3	UID/RST Button	7	Server and Chassis Latch
4	LED	8	3.5” Drive

5.1.3 10 × 2.5” Front Panel

Figure 5-3 Front View

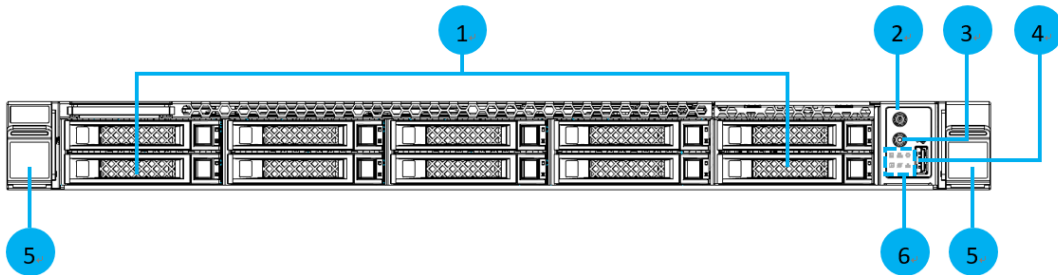

1	2.5” Drive Module	4	USB 2.0 Port
2	Power Button	5	Server and Chassis Latch
3	UID/RST Button	6	LED

5.1.4 8 × 2.5” + 2 × E1.S SSD+ 2 × M.2 SSD+ VGA Front Panel

Figure 5-4 Front View

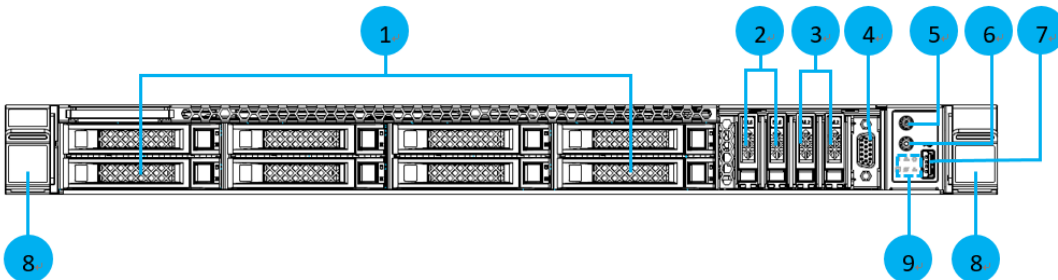

1	2.5” Drive Module	6	UID/RST Button
2	E1.S SSD	7	USB 2.0 Port
3	M.2 SSD	8	Server and Chassis Latch
4	VGA Port	9	LED
5	Power Button		

5.1.5 12 × 2.5” Front Panel

Figure 5-5 Front View

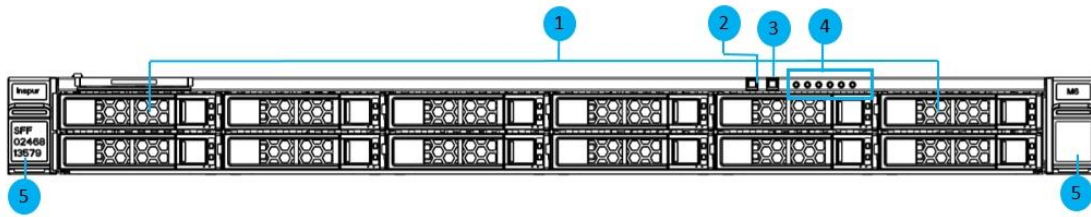

1	2.5" Drive Module	4	LED
2	Power Button	5	Server and Chassis Latch
3	UID/RST Button		

5.1.6 32 × E1.S SSD Front Panel

Figure 5-6 Front View

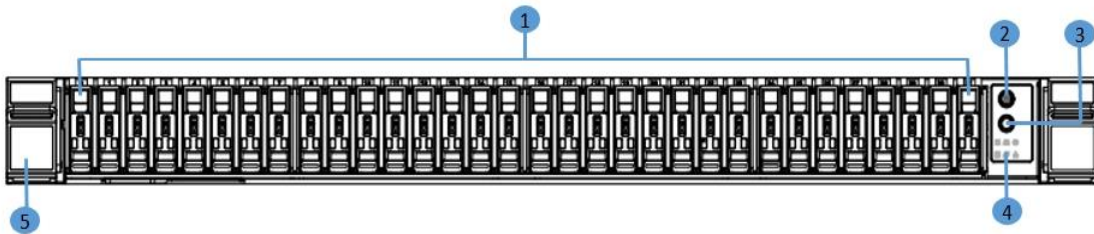

1	E1.SSD Module	4	LED
2	Power Button	5	Server and Chassis Latch
3	UID/RST Button		

5.1.7 T-Shape Model Front Panel

Figure 5-7 Front View

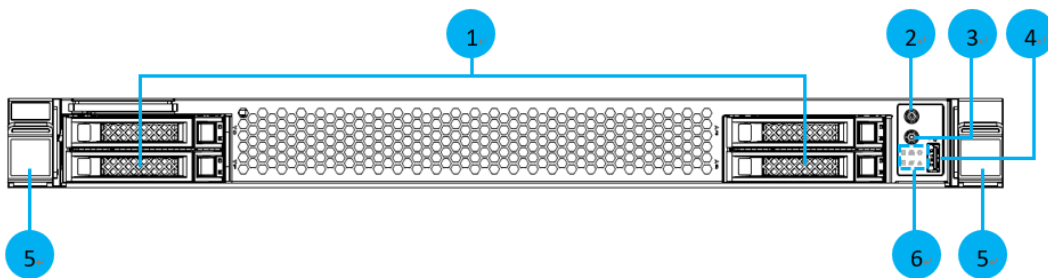

1	2.5" Drive Module	4	USB 2.0 Port
2	Power Button	5	Server and Chassis Latch
3	UID/RST Button	6	LED

5.1.8 2.5"/3.5" Drive Tray LED

Figure 5-8 Drive Tray LED

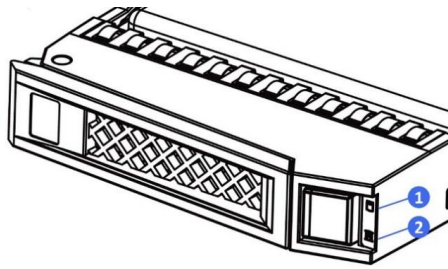

No.	Module	Description
1	Activity Status LED	Solid green = Normal Flashing green = Read/write activities
2	Drive Fault LED	Solid red = Drive error or failed Solid blue = Drive is being located Solid pink = RAID rebuilding

5.2 Rear Panel

5.2.1 1 × PCIe + 2 × 2.5"

Figure 5-9 Front View

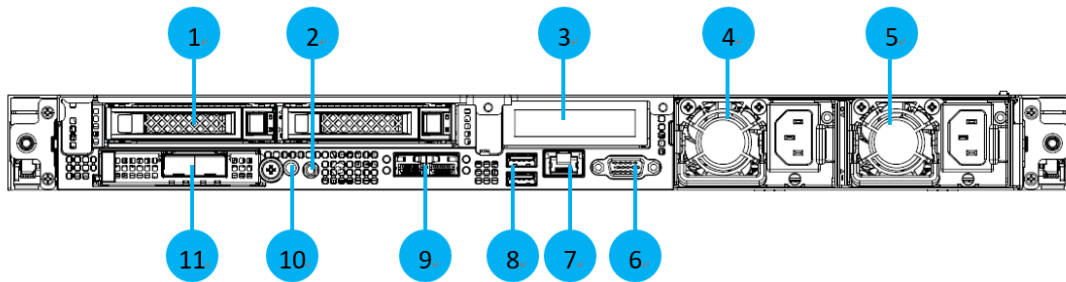

No.	Module	No.	Module
1	Rear 2.5" Drive Module	7	BMC Network Interface
2	System Serial Port	8	2 × USB Port (compatible with USB 3.0/2.0)
3	CPUo PCIe x16 HHHH	9	Onboard X710 10 G Network Interface
4	PSUo	10	UID Button
5	PSU1	11	OCP3.0 Module
6	VGA Port		

5.2.2 2 × PCIe

Figure 5-10 Front View

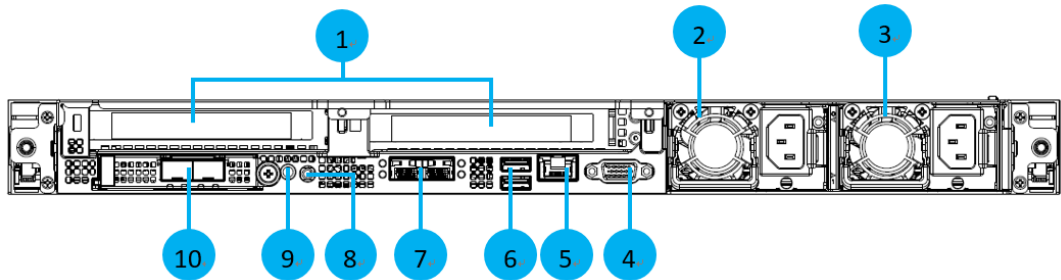

1	PCIe X16 FHHL (right: CPU ₀ ; left: CPU ₁)	7	Onboard X710 10 G Network Interface
2	PSU ₀	8	System Serial Port
3	PSU ₁	9	UID Button
4	VGA Port	10	OCP3.0 Module
5	BMC Network Interface		
6	2 × USB Port (compatible with USB 3.0/2.0)		

5.2.3 3 × PCIe

Figure 5-11 Front View

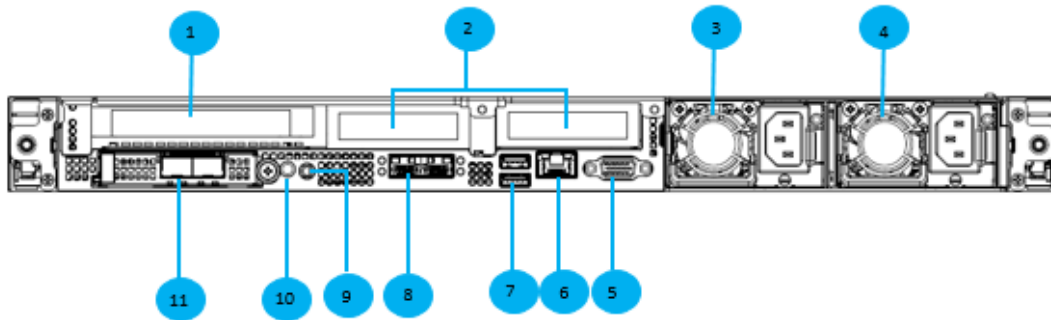

1	CPU ₁ PCIe x16 FHHL	7	2 × Onboard USB Port (compatible with USB 3.0/2.0)
2	PCIe x16 HHHH (left: CPU ₁ ; right: CPU ₀)	8	Onboard X710 10 G Network Interface
3	PSU ₀	9	System Serial Port
4	PSU ₁	10	UID Button
5	VGA Port	11	OCP3.0 Card

6	BMC Network Interface		
---	-----------------------	--	--

5.3 Internal Top View

Figure 5-12 Internal Top View for Server 2PCIE

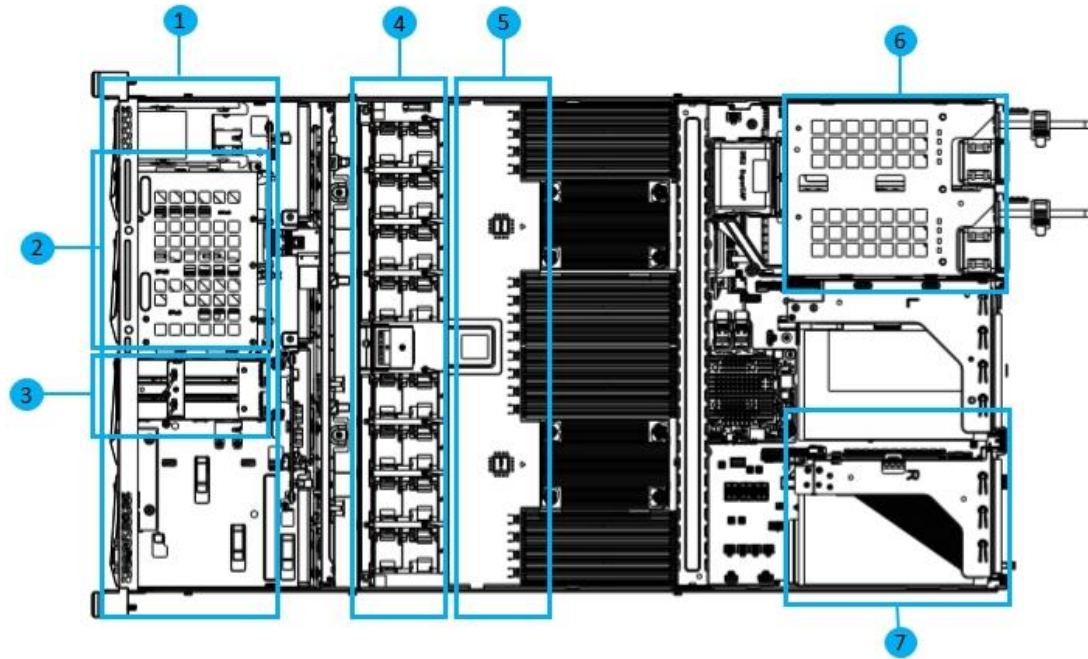

No.	Module	No.	Module
1	3.5" Drive Slot	5	Air Director
2	E1.S Drive Slot	6	Power Supply Unit
3	M.2 Drive Tray	7	Riser Cage Module
4	Fan Module		

Figure 5-13 Internal Top View for Server 1PCIe+2X2.5"

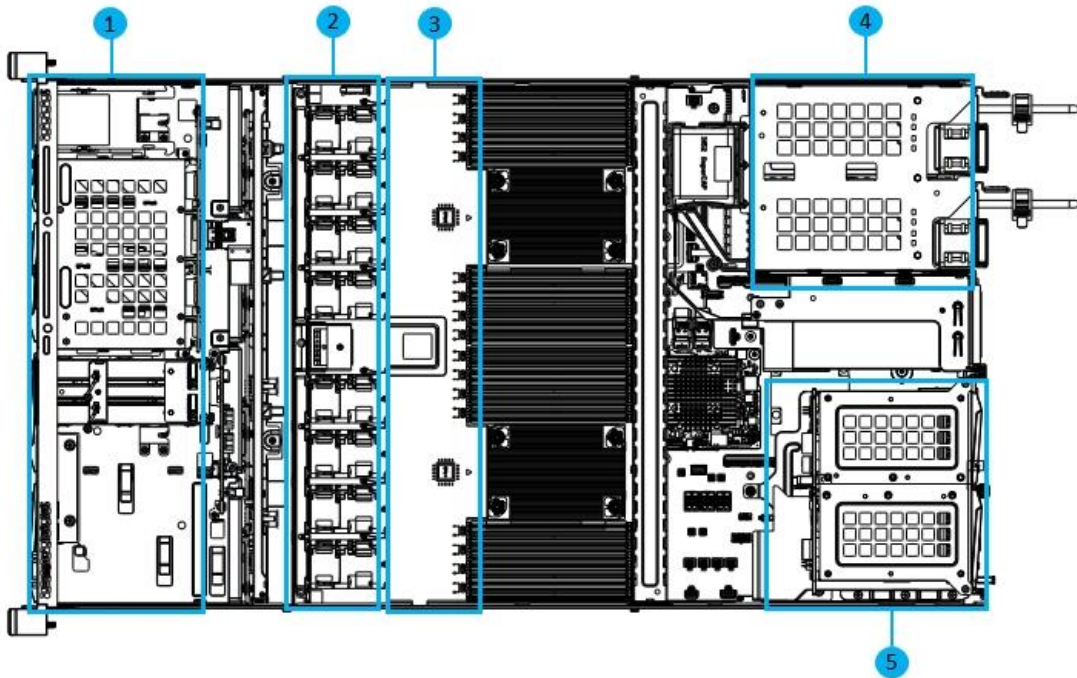

No.	Module	No.	Module
1	2.5"/3.5" Drive Slot	4	Power Supply Unit
2	Fan Module	5	Rear 2 × 2.5" Module
3	Air Director		

Figure 5-14 Internal Top View for Server 3PCIe

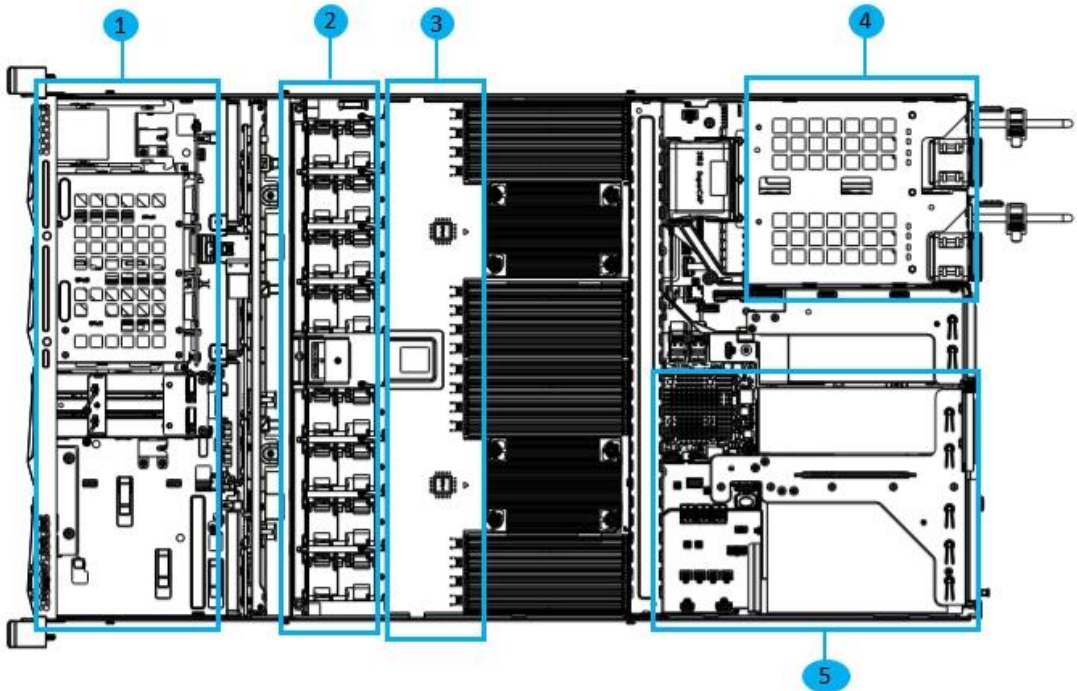

No.	Module	No.	Module

1	2.5"/3.5" Drive Slot	4	Power Supply Unit
2	Fan Module	5	Butterfly Card Module
3	Air Director		

5.4 OCP3.0 Module

Figure 5-15 OCP 3.0 Module

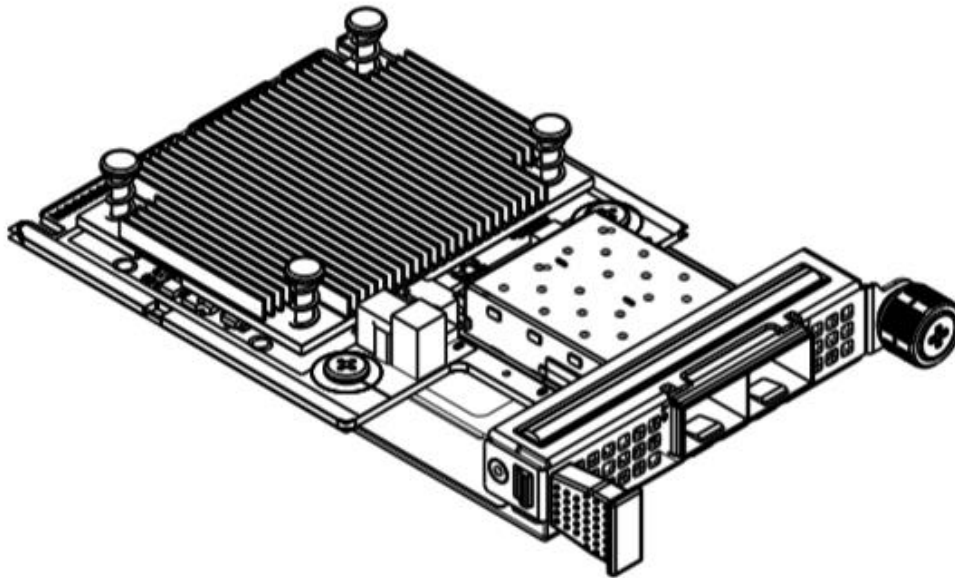

5.5 M.2 SSD Module

Figure 5-16 M.2 Module

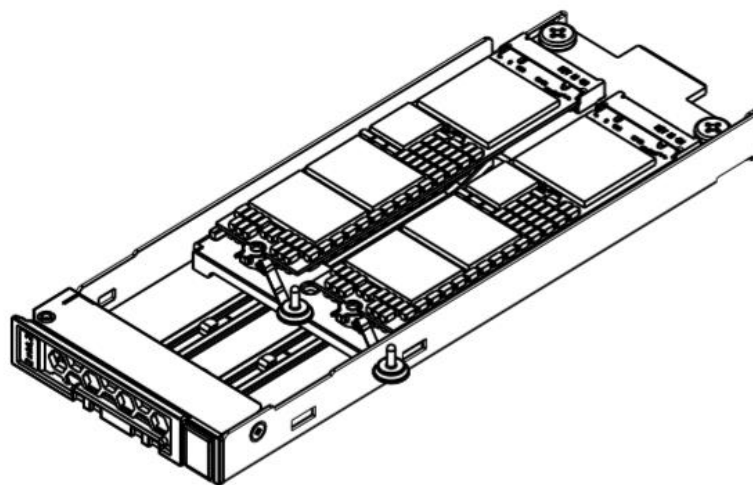

5.6 X4 M.2 Module

Figure 5-17 X4 M.2 Module

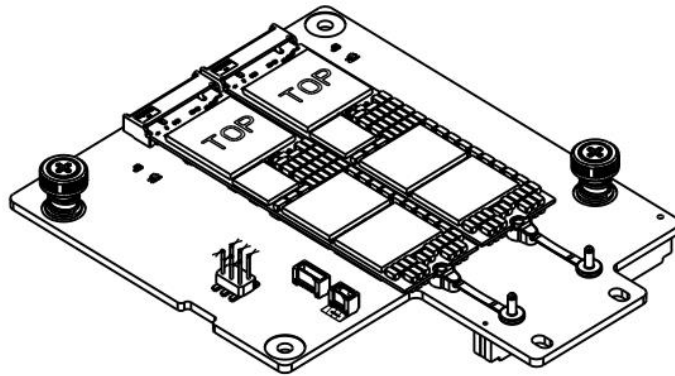

5.7 2 × M.2 SSD + 2 × E1.S SSD Module

Figure 5-18 2 × M.2 SSD + 2 × E1.S SSD Module

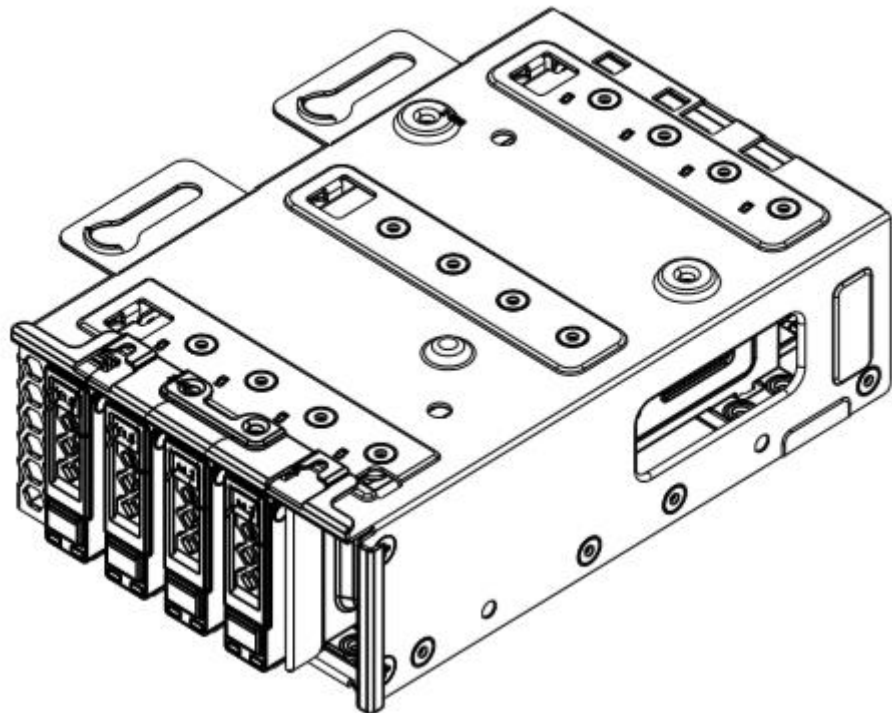

5.8 Mainboard Layout

Figure 5-19 Mainboard Layout

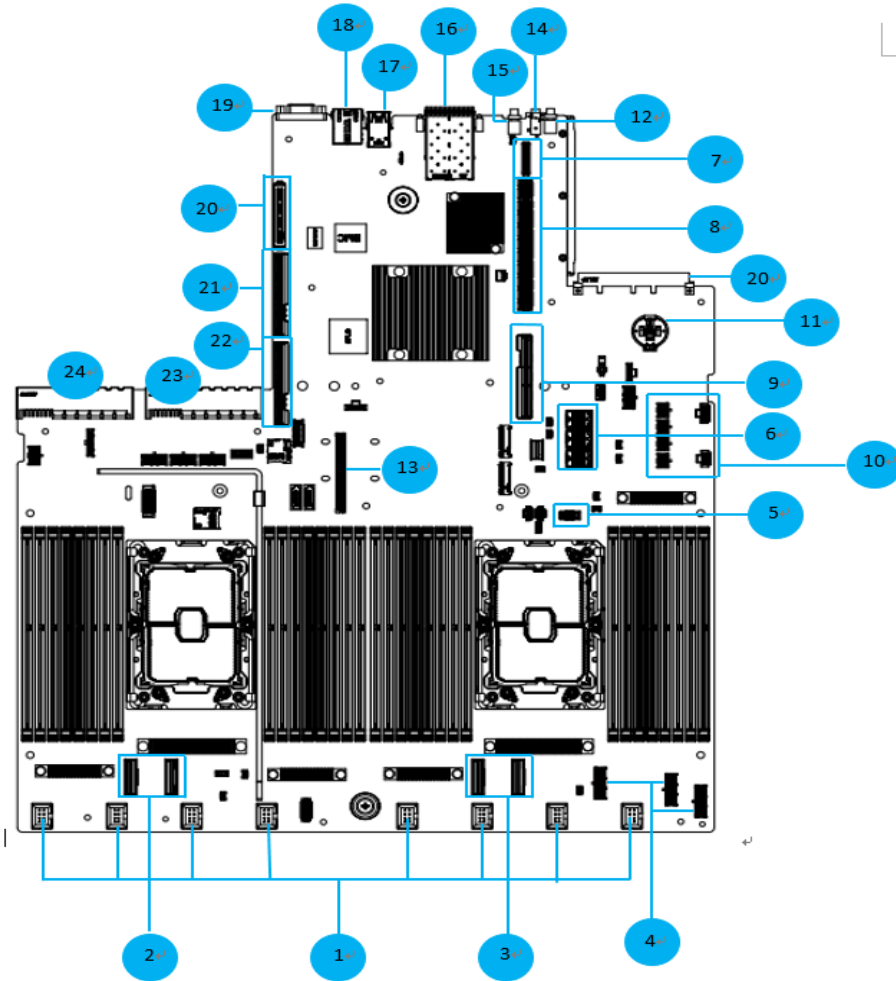

No.	Module	No.	Module
1	Fan Interface	16	Dual-Port 10 Gb SFP Ethernet Adapter
2	CPU0 PE3 Slimline Slot	17	2 x USB 3.0 Port
3	CPU1 PE3 Slimline Slot	18	BMC Network Interface
4	Front Backplane Power Connector	19	VGA Port
5	VPP Connector	20	Power Connector
6	3 x MiniSAS HDD Port	21	PCIe x16_CPU0 Slot
7	Power Interface	22	PCIe x16_CPU0 Slot
8	PCIe x16_CPU1 Slot	23	PSU0 Connector
9	PCIe x16_CPU1 Slot	24	PSU1 Connector
10	Power Connector		
11	RTC Battery Connector		
12	UID LED & Button		
13	RAID Card Connector		
14	System Serial Port		

15	Power LED & Button		
----	--------------------	--	--

5.9 Mainboard Differences

Part No.	Difference
YZMB-01642-101	Supported: full-featured mainboard, TF card, LCD screen, RAID Mezz or X4 PCIe M.2, Infineon VR, and BMC/BIOS dual flash; Not supported: onboard M.2 and onboard X710 & i350
YZMB-01642-106	Supported: onboard M.2 mainboard, TF card, Infineon VR, and BMC dual flash; Not supported: RAID Mezz and X4 PCIe M.2, and onboard X710 & i350
YZMB-01642-107	Supported: RAID Mezz or X4 PCIe M.2, MPS VR, and BMC dual flash; Not supported: onboard M.2 and onboard X710 & i350
YZMB-01642-108	Supported: onboard X710 10 G mainboard, RAID Mezz or X4 PCIe M.2, MPS VR, and BMC dual flash; Not supported: onboard M.2
YZMB-02738-101	Supported: onboard i350 1 G mainboard, RAID Mezz or X4 PCIe M.2, MPS VR, and BMC dual flash; Not supported: onboard M.2

5.10 Relationship Between Front and Rear Windows

Front Window	Rear Window	Cover with Hole or Not
4 × 3.5" + 2 × E1.SS SSD + 2 × M.2 SSD	2 × full-height and half-length card	With Hole
	2 × half-height and half-length card + 1 × full-height and half-length card	With Hole/Without Hole
	2 × rear drive + 1 × half-height and half-length card	With Hole/Without Hole
4 × 3.5" + 4 × 2.5"	2 × half-height and half-length card + 1 × full-height and half-length card	With Hole/Without Hole
	2 × rear drive + 1 × half-height and half-length card	With Hole/Without Hole
10 × 2.5"	2 × full-height and half-length card	With Hole
	2 × half-height and half-length card + 1 × full-height and half-length card	With Hole/Without Hole
	2 × rear drive + 1 × half-height and half-length card	With Hole/Without Hole
8 × 2.5" + 2 × E1.S SSD + 2 × M.2	2 × half-height and half-length card + 1 × full-height and half-length card	With Hole/Without Hole
	2 × rear drive + 1 × half-height and half-length card	With Hole/Without Hole
12 × 2.5"	2 × half-height and half-length card + 1 × full-height and half-length card	With Hole/Without Hole
	2 × rear drive + 1 × half-height and half-length card	With Hole/Without Hole
32 × E1.S SSD	2 × full-height and half-length card	With Hole

T-Shape	2 × half-height and half-length card + 1 × full-height and half-length card	With Hole
	2 × rear drive + 1 × half-height and half-length card	With Hole

6 System Specifications

Table 6-1 System Specifications

Component	Description
Release Date	2021
Specification	1U rack-mounted
Processor	1 to 2 Intel® Xeon® Scalable processors (6300 and 8300 and 5300 and 4300 series): Up to 40 cores (with a frequency of 2.3 GHz) Max. frequency of 3.6 GHz (with 8 cores) 3 UPI links and up to 11.2 GT/s per link Max. L3 cache capacity of 1.5 M per core Max. TDP of 270 W
Chipset	Intel C621A
Memory	Up to 32 DIMMs (RDIMM and BPS) at the max. speed of 3200 MT/s, with 8 memory channels per processor, and up to 2 memory slots per channel. ECC, memory mirroring, and memory rank sparing are supported.
Storage	Front Panel 12 × 2.5" hot-swap SATA/SAS/NVMe drive (max. 12 NVMe drives) 32 × hot-swap E1.S SSD 4 × 3.5" SAS/SATA/NVMe + 2 × M.2 SSD (hot-swap not supported) + 2 × E1.S SSD 4 × 3.5" SAS/SATA/NVMe + 4 × 2.5" hot-swap SAS/SATA/NVMe 10 × 2.5" hot-swap SATA/SAS/NVMe 8 × 2.5" SATA/SAS/NVMe + 2 × E1.S SSD + 2 × M.2 SSD (hot-swap not supported) Rear Panel 2 × 2.5" hot-swap SATA/SAS drives Built-in Storage Up to 2 TF cards respectively for BIOS and BMC Up to 2 SATA M.2 drives Up to 2 PCIe X4 M.2 drives
Storage Controller	RAID Controller SAS Controller On-board PCH can supports 14*SATA interface (2* SATA 7pin + 3* Mini SAS HD) Intel on board NVMe controller with option intel NVMe RAID Key
Network	1 OCP 3.0 module (options: 1 Gb/s, 10 Gb/s, 25 Gb/s, 40 Gb/s, and 100 Gb/s) Dual 10 G onboard network interfaces with the speed of 10 Gb/s Dual 1 G onboard network interfaces with the speed of 1 Gb/s Standard 1Gb/10Gb/25Gb/40Gb/100Gb NICs is supported.
I/O Expansion Slot	Up to 3 standard x16 PCIe cards and 1 OCP3.0 NIC, one option X8 Mezz slot

	2 standard x16 PCIe cards for the single CPU
Port	2 rear USB 3.0 ports + 1 front USB 3.0 ports + 1 front USB 2.0 ports 1 front VGA port 1 rear VGA port 1 rear BMC serial port
Fan	8 hot-swap 4056 fans with N+1 redundancy
Power Supply	A 550/800/1300 W or above power supply that supports 1+1 redundancy 110 VAC - 230 VAC: 90 V - 264 V 240 VDC: 180 V - 320 V 336 VDC: 260 V - 400 V -48VDC: -40 V - -72 V
System Management	Integrates an independent 1000 Mbps network interface specifically for remote IPMI management
Operating System	Microsoft Windows Server 2008/2012/2016/2019 Red Hat Enterprise Linux 6/7 SUSE Linux Enterprise Server 11/12

Table 6-2 Physical Specifications

Component	Description
Server Size (Width × Height × Depth)	With mounting ears: 482 mm × 43.05 mm × 811.8 mm 32E1.S: 482 mm × 43.05 mm × 871.8 mm Without mounting ears: 438 mm × 43.05 mm × 780 mm 32E1.S: 438 mm × 43.05 mm × 840 mm
Package Size (Length × Width × Height)	780case: 1031 mm × 651 mm × 247 mm 840case: 1080 mm × 600 mm × 240 mm
Weight	4 × 3.5" configuration (including rear 2.5" drives) Server (packed): ~21 kg Gross weight (unpacked): 31.5 kg (including package + rail kit + component box) 10 × 2.5" configuration (including rear 2.5" drives) Server (packed): ~21 kg Gross weight (packed): 31 kg (including package + rail kit + component box)
Temperature	Operating temperature: 5°C to 45°C ^{1,2,3} Storage temperature (packed): -40°C to 70°C Storage temperature (unpacked): -40°C to 70°C

Humidity	Operating humidity: 5% - 95% R.H. Storage humidity (packed): 5% - 95% R.H. Storage humidity (unpacked): 5% - 95% R.H.
Noise (Bels) (Sound power level) ^{4,5,6,7}	4 × 3.5" typical configuration at the ambient temperature of 23°C Idle Sound pressure level: 51.2 dBA; Sound power level: 59.8 dBA Operating 70% loading Sound pressure level: 57.4 dBA; Sound power level: 71.8 dBA Operating 100% loading 61.8 dBA Sound pressure level: 61.8 dBA; Sound power level: 75.2 dBA
Elevation	Operating temperature: 5°C - 40°C at 0 - 914 m (0 - 3000 ft) Operating temperature: 10°C - 32°C at 914 - 2133 m (3000 - 7000 ft)

Table 6-3 Operating Temperature Specifications

Configuration Name		Temperature	Front Drive	Rear Drive	BPS	CPU	GPU
4 × 3.5" + 2 × E1.S SSD + 2 × M.2 SSD	Rear NIC configuration	35°C fan normal 30°C fan fail	4 × 3.5"	N/A	Supported ≤ 165 W for CPUs	≤ 205 W	N/A
	Rear GPU configuration		4 × 3.5"	N/A	Not supported	≤ 165 W	T4 and other GPUs
	Rear drive configuration		4 × 3.5"	SSDs	Not supported	≤ 205 W	N/A
10 × 2.5" SFF	Rear NIC configuration	35°C fan normal 30°C fan fail	8 × 2.5"	N/A	Supported ≤ 165 W for CPUs	≤ 205 W	N/A
	Rear GPU configuration		8 × 2.5"	N/A	Not supported	≤ 165 W	T4 and other GPUs
	Rear drive configuration		8 × 2.5"	SSDs	Not supported	≤ 205 W	N/A
12 × 2.5" SFF	Rear NIC configuration	35°C fan normal 30°C fan fail	12 × 2.5"	N/A	Supported ≤ 165 W for CPUs	≤ 205 W	N/A
	Rear GPU configuration		12 × 2.5"	N/A	Not supported	≤ 165 W	T4 and other GPUs
	Rear drive configuration		12 × 2.5"	SSDs	Not supported	≤ 205 W	N/A
32 × E1.S SSD	Rear NIC configuration	35°C fan normal 30°C fan fail	32 × E1.S	N/A	Supported ≤ 165 W for CPUs	≤ 165 W	
	Rear GPU configuration		32 × E1.S	N/A	Not supported		T4 and other GPUs
T-Shape model	Rear NIC configuration	35°C fan normal	4 × 2.5"	N/A	Not supported	> 205 W	Not supported
	Rear GPU configuration	35°C fan normal	4 × 2.5"	N/A	Not supported	> 205 W	T4 and other GPUs
	Rear drive configuration	35°C fan normal	4 × 2.5"	SSDs	Not supported	> 205 W	N/A

Notes:

1. Not all configurations support an operating temperature range of 5°C - 45°C.

2. Standard operating temperature

10°C - 35°C at sea level (50°F - 95°F). Every 305 m increase in the altitude above sea level reduces the operating temperature range by 1.0°C (a 1.8°F drop per 1000 ft). The maximum operating altitude is 3050 m (10000 ft). Please keep the product away from direct sunlight. The maximum rate of change is 20°C/hr (36°F/hr). The operating altitude and maximum rate of change vary with different system configurations.

Any fan failure or operations above 30°C (86°F) may lead to poor system performance.

3. Operating temperature at scaled environments

As for certain approved configurations, the entry range of the supported system at sea level can be scaled to 5°C - 10°C (41°F - 50°F) and 35°C - 45°C (95°F - 104°F). At an altitude of 900 - 3050 m (2953 - 10000 ft) above sea level, every 175 m increase in the altitude reduces the operating temperature range by 1.0°C (a 1.8°F drop per 574 ft).

As for certain approved configurations, the entry range of the supported system at sea level can be scaled to 35°C - 45°C (104°F - 113°F). At an altitude of 900 - 3050 m (2953 - 10000 ft) above sea level, every 125 m increase in the altitude reduces the operating temperature range by 1.0°C (a 1.8°F drop per 410 ft).

Any fan failure or operations at the scaled environments may lead to poor system performance.

4. This document lists the weighted sound power level (LWAd) and the weighted sound pressure level (LpAm) of the product at an operating temperature of 23°C. The values are reported according to the ISO7779 (ECMA 74) noise measurement standards and ISO 9296 (ECMA 109). The listed sound levels are applicable to general shipping configurations and other options may increase the volume. Please contact your sales representative for more information.

5. The sound levels shown here were measured according to specific test configurations. The sound level will vary with different system configurations. Values are subjected to change without notice and are for reference only.

6. The sample (model) test assessments meet the referenced product specifications. This product or product series are eligible to have appropriate compliance labels and declarations.

7. All sound levels listed are for standard shipping configurations and other system configurations may increase the volume.

Table 6-4 Safety & EMC

<p>Safety</p>	<p>IEC 60950-1:2005 (Second Edition); Am1:2009 + Am2:2013 IEC 60950-1:2005 EN 60950-1:2006+A11:2009+A1:2010+A12:2011+A2:2013 GB4943.1-2011 UL 60950-1 and CAN/CSA C22.2 No. 60950-1-07 Standard for Information Technology Equipment-Safety-Part 1: General Requirements EN 62368-1:2014/A11:2017, IEC 62368-1:2014 (Second Edition) TC 004/2011 UL 62368-1: Audio/video, information and communication technology equipment Part 1: Safety requirements CAN/CSA C22.2 No. 62368-1-14: Audio/video, information and communication technology equipment Part 1: Safety requirements TP TC 004/2011 GB4943.1-2011 TC 004/2011</p>
<p>EMC</p>	<p>GB/T9254-2008 (idt CISPR 22:2006) GB17625.1-2012 (idt IEC 61000-3-2:2009) EN 55032:2015 EN 61000-3-2:2014 EN 61000-3-3:2013 EN 55024:2010 + A1:2015 EN 55035:2017 AS/NZS CISPR 32:2015 CFR 47 FCC Part 15 Subpart B, 2018 ICES-003 ISSUE 6:2016 TC 020/2011 KN32 KN35</p>

Table 6-5 Industry Standard Compliance

ACPI 6.1 Compliant
PCI-E 4.0 Compliant
WOL Support
SMBIOS 3.1
UEFI 2.6
Redfish API
IPMI 2.0
Microsoft® Logo certifications
PXE Support
Advanced Encryption Standard (AES)
SNMP v3
TLS 1.2
Active Directory v1.0
TPM 2.0
USB 2.0/3.0 Compliant

7 Compatibility List

※ The compatibility list was updated on 2021/03. For the latest compatibility configuration and the parts and models not listed in this manual, please contact Inspur Customer Service.

7.1 Processor

NF5180M6 supports two Intel® Xeon® Scalable processors.

Table 7-1 CPU

Model	Cores	Base Frequency	TDP
CPU_I_6314U-Xeon2.3_32C_48M_205W-D2	32	2.3	205
CPU_I_6346-Xeon3.1_16C_24M_205W-D2	16	3.1	205W
CPU_I_6354-Xeon3.0_18C_27M_205W-D2	18	3.0	205
CPU_I_6330-Xeon2_28C_42M_205W-D2	28	2.0	205
CPU_I_6348-Xeon2.6_28C_42M_235W-D2	28	2.6	235
CPU_I_6338-Xeon2.0_32C_48M_205W-D2	32	2.0	205
CPU_I_6330N-Xeon2.2_28C_42M_165W-D2	28	2.2	165
CPU_I_6338N-Xeon2.2_32C_48M_185W-D2	32	2.2	185
CPU_I_8380-Xeon2.3_40C_60M_270W-D2	40	2.3	270
CPU_I_8352V-Xeon2.1_36C_54M_195W-D2	2.1	2.1	195
CPU_I_8360Y-Xeon2.4_36C_54M_250W-D2	2.4	2.4	250
CPU_I_8358-Xeon2.6_32C_48M_250W-D2	2.6	2.6	250
CPU_I_8352Y-Xeon2.2_32C_48M_205W-D2	32	2.2	205
CPU_I_8358P-Xeon2.6_32C_48M_240W-D2	32	2.6	240
Ice Lake SP HCC Intel(R) Xeon(R) Silver 4310 12c 120W 2.1GHz M-1 QS QXRN	12	2.1	120
Ice Lake SP HCC Intel(R) Xeon(R) Silver 4314 16c 135W 2.4GHz M-1 QS QXS8	16	2.4	135
Ice Lake SP HCC Intel(R) Xeon(R) Silver 4316 20c 150W 2.3GHz M-1 QS QXS5	20	2.3	150
Ice Lake SP HCC Intel(R) Xeon(R) Gold 5317 12c 150W 3.0GHz M-1 QS QXRM	12	3.0	150
Ice Lake SP HCC Intel(R) Xeon(R) Gold 5320 26c 185W 2.2GHz M-1 QS QXRT	26	2.2	185
Ice Lake SP HCC Intel(R) Xeon(R) Silver 4309Y 8c 105W 2.8GHz M-1 QS QXRS	8	2.8	105
Ice Lake SP HCC Intel(R) Xeon(R) Silver 4310T 10c 105W	10	2.3	105

2.3GHz M-1 QS QXRP			
Ice Lake SP HCC Intel(R) Xeon(R) Gold 5315Y 8c 140W 3.2GHz M-1 QS QXRR	8	3.2	140
Ice Lake SP HCC Intel(R) Xeon(R) Gold 5318N 24c 150W 2.1GHz M-1 QS QXS4	24	2.1	150
Ice Lake SP HCC Intel(R) Xeon(R) Gold 5318Y 24c 165W 2.1GHz M-1 QS QXS2	24	2.1	165

7.2 Memory

NF5180M6 supports up to 32 DDR4 DIMMs. Each processor supports 8 memory channels, and each channel supports 2 memory slots. RDIMM/BPS is supported. and the following memory protection technologies:

- Partial Cache Line Sparing (PCLS)
- DDR4 Command/Address Parity Check and Retry
- Memory Demand and Patrol Scrubbing
- Memory Data Scrambling with Command and Address
- Memory Mirroring-Intra iMC
- PMem Single Device Data Correction (SDDC)
- PMem Double Device Data Correction (DDDC)
- DDRT Data ECC (Read & Write)
- PMem Address Verification and Retry
- PMem Memory Address Range Scrub (ARS)
- DDR4 Write Data CRC Check and Retry
- Memory disable/map-out for FRB
- Power-up DDR4 Post Package Repair (PPR)
- Failed DIMM Isolation
- Address range/partial memory mirroring

Table 7-2 Memory List

Memory Type	Max. Capacity	Description
DDR4	512G	Memory_SA_16G_DDR4-3200ER_1R4_D18F
	512G	Memory_SA_16G_DDR4-3200ER_2R8_D18F
	512G	Memory_MT_16G_DDR4-3200ER_2R8_E18F

	1024GB	Memory_SK_32G_DDR4-3200ER_2R4_D36J
	1024GB	Memory_SA_32G_DDR4-3200ER_2R4_D36F
	1024GB	Memory_MT_32G_DDR4-3200ER_2R8_E18F
	1024GB	Memory_MT_32G_DDR4-3200ER_2R4_E36F
	2048GB	Memory_SA_64G_DDR4-3200ER_2R4_A36F
Optane® PMem 200	2948GB	16×128GB Optane® PMem @3200

Notes:

1. The server does not support mixed use of DIMMs of different types and specifications.
2. Two processors can maximize the memory capacity. When only one processor is installed, the maximum memory capacity will be half of the display capacity.

Table 7-3 Common DIMM Insertion Methods

Memory Slot		Memory Quantity									
		1	2	3	4	8	12	16	24	32	
CPU ₀	C1D0						●	●	●	●	
	C1D1								●	●	
	C0D0	●	●	●	●	●	●	●	●	●	
	C0D1								●	●	
	C3D0							●		●	
	C3D1									●	
	C2D0					●	●	●	●	●	
	C2D1								●	●	
	C6D1								●	●	
	C6D0					●	●	●	●	●	
	C7D1									●	
	C7D0							●		●	
	C4D1									●	●
	C4D0			●	●	●	●	●	●	●	
	C5D1									●	●
C5D0						●	●	●	●		
CPU ₁	C1D0						●	●	●	●	
	C1D1								●	●	
	C0D0		●	●	●	●	●	●	●	●	
	C0D1								●	●	
	C3D0							●		●	
	C3D1									●	
	C2D0					●	●	●	●	●	

Model	Rpm	Capacity
3.5 SATA HDD	seagate	2T/4T/6T/8T/10T/12T/14T/16T
	toshiba	6T/8T/10T/12T/14T
	HGST	4T/6T/8T/10T/12T/14T/16T/18T

Note: Mixed use of 2.5" and 3.5" drives of not more than three types is allowed. U.2 NVMe SSD

7.3.2 U.2 NVMe SSDs

Model	Capacity	Max. No.
U.2 NVMe SSD	1.6T	12
U.2 NVMe SSD	3.2T	12
U.2 NVMe SSD	6.4T	12
U.2 NVMe SSD	7.68T	12

Note: For those models unlisted in the above table, please contact Inspur Customer Service.

7.4 Drive Backplane

Table 7-8 Drive Backplanes

Type	Description	Support
Front 4 × 3.5" SATA/SAS	Backplane_Inspur_NF5180M6_Backplane_4 × 3.5" _SAS_SATA	Connection to SAS/SATA drives through RAID and SAS cards Onboard SATA NVMe not supported
Front 4 × 3.5" _SAS_SATA_NVMe	Backplane_Inspur_5280M6_4 × 3.5" _SAS_SATA_NVMe_GEN4	Connection to SAS/SATA drives through RAID and SAS cards Onboard SATA 4 × NVMe
Front 2 × E1.S SSD	Backplane_Inspur_5180M6_2 × E1.S Backplane	Hot-swap
Front M.2 SSD	Backplane_Inspur_NF5180M6_M.2 Backplane	Connection to SATA M.2 drives through RAID and SAS cards Onboard SATA
Front 8 × 2.5" SATA_SAS Backplane	Backplane_Inspur_NF5180M6_8 × 2.5" SATA_SAS	Connection to SAS/SATA drives through RAID and SAS cards Onboard SATA
Front 8 × 2.5" SAS/SATA/NVMe backplane	Backplane_Inspur_NF5180M6_8 × 2.5" SAS_SATA_NVME	Connection to SAS/SATA drives through RAID and SAS cards 8 × NVMe
Front 12 × 2.5" SAS/SATA/NVMe	Backplane_Inspur_NF5180M6_12×2.5" SAS/SATA/NVME	Connection to SAS/SATA drives through RAID and SAS cards 12 × SATA/SAS

Type	Description	Support
		12 × NVMe
Front 32 × E1.S SSD	Backplane_Inspur_NF5180M6_32 × E1.S SSD	32 × E1.S SSD
Front 4 × 2.5" SAS/SATA/NVMe	Backplane_Inspur_5180M6_4×2.5" SAS/SATA/NVMe backplane	Connection to SATA drives through RAID and SAS cards 4 × SATA/SAS 4 × NVMe
Rear 2 × 2.5" SAS/SATA	Backplane_Inspur_NF5180M6_SAS_SATA_2.5_x2	Connection to SATA drives through RAID and SAS cards Onboard SATA
Front 2 × 2.5" SAS/SATA	Backplane_Inspur_NF5180M6_Backplane_2 × 2.5" SAS_SATA	Connection to SATA drives through RAID and SAS cards Onboard SATA
Front 2.5" NVMe	Backplane_Inspur_NF5180M6_NVME_2 × 2.5" Slimx8	2 × NVMe
2 × Built-in PCIe M.2	Backplane_Inspur_NF5180M6_2 × M.2_NVMe_Gen4	2 × Built-in PCIe M.2

7.5 Drive Installation Position

7.5.1 Drive Installation Sequence

4 × 3.5" + 2 × E1.S + 2 × M.2:

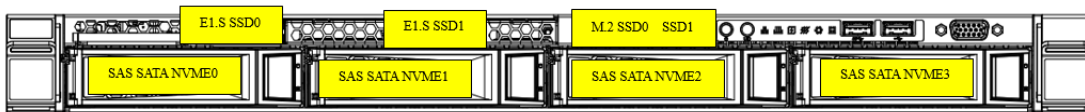

4 × 3.5" + 4 × 2.5"



8 × 2.5" + 2 × E1.S + 2 × M.2:

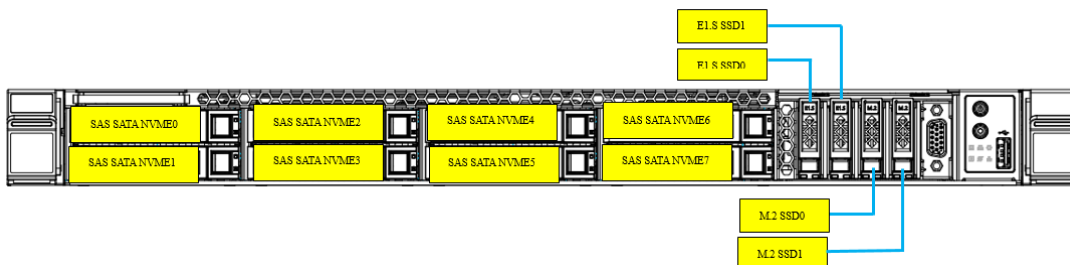

10 × 2.5":

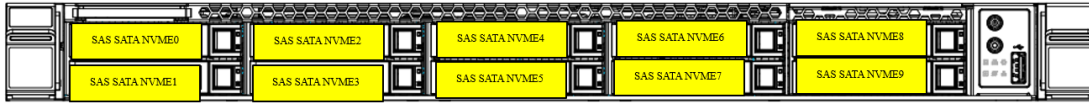

12 × 2.5”:

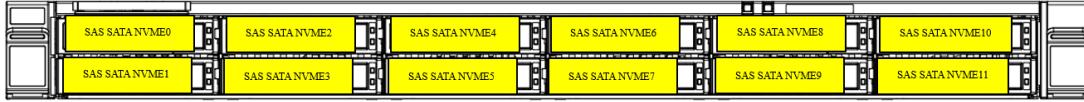

32 × E1.S SSD:

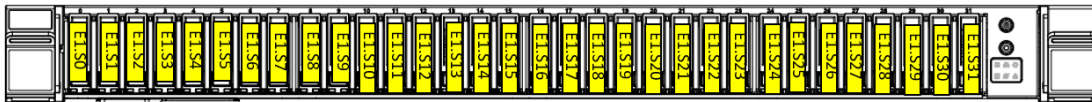

T-Shape 4 × 2.5”

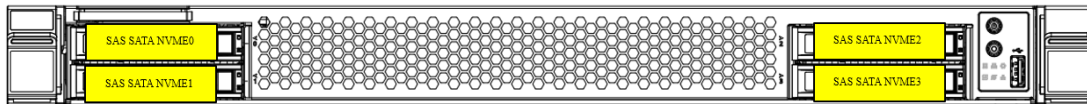

Rear panel 2 × 2.5”:



7.6 RAID/SAS Card

Table 7-9 RAID/SAS Cards

Type	Description	Support	Super Capacitor Module
SAS Card	SAS Card_L_8Ro_3408IMR_HDM12G_PCIE3_Mezz_S		
	SAS Card_Inspur_PM8222_SmartHBA_8_SAS3_PCIE3		
	SAS Card_L_8Ro_9400-8i_HDM12G_PCIE3		
	SAS Card_L_8Ro_3408IT_HDM12G_PCIE3_Mezz_S		
	SAS Card_Inspur_PM8222_PM8222_8_SAS3_PCIE		
	PM8252 8i SAS Card_Inspur_PM8252_HBA_8_SAS4_PCIE4		

RAID Card	RAID Card _Inspur_PM8204_RA_8_2GB_SAS3_PCIE3	Yes
	RAID Card _L_8Ro_9460-8i_2GB_HDM12G_PCIE3	Yes
	RAID Card _L_16Ro_9460-16i_4GB_HDM12G_PCIE3	
	RAID Card _L_8Ro_3508_4GB_HDM12G_PCIE3_Mezz_S	
	RAID Card _L_8Ro_9361-8i_1G_HDM12G_PCIE3	Yes
	RAID Card _L_8Ro_9361-8i_2G_HDM12G_PCIE3	

7.7 NIC

Table 7-10 OCP 3.0 NICs

Type	Model & Description	Speed	Interfaces
OCP	Intel X550 Dual Port OCP3.0	10G	1
	mellanox CX5 Dual Port OCP 3.0	100G	1
	intel E810 Dual Port OCP 3.0	25G	1
	NIC_M_100G_MCX566ACDAB_LC_OCP3x16_2_XR	100G	1
	BROADCM_25G_57414_LC_OCP3x16_2_XR	25G	1
	NIC_Mellanox_25G_MCX631432AN-ADAB_Dual Port _OCP3.0	25G	1

Table 7-11 Standard PCI-E NICs

Type	Model & Description	Speed	Interfaces
PCI-E Nic	NIC_I_10G_X550T2_RJ_PCIE4_2_XR	10G	3
	NIC_I_10G_X710DA2_LC_PCIE8_2_XR	10G	3
	NIC_Intel_25G_E810XXVDA2_Dual Port _PCIE4.0_Co	25G	3
	NIC_I_40G_XL710_LC_PCIE8_2_MM	40G	3
	NIC_M_25G_MCX512A-ACAT_LC_PCIE8_2_XR	25G	3
	NIC_INSPUR_82599ES_10G_LC_PCIE8_Dual Port _XR	10G	3
	NIC_Inspur_W_I350AM4_1G_RJ45_PCIE8_Four Port	1Gbase-T	3
	NIC_SND_W_I350-AM2_RJ_PCI-E4X_1KM_Dual Port	1Gbase-T	3
	NIC_Intel_25G_E810XXVDA2_Dual Port _PCIE4.0_Co	100G	1
	NIC_M_100G_MCX516A-CCAT_LC_PCIE16_2_XR	100G	1
	NIC_INSPUR_82599ES_10G_LC_PCIE8_Dual Port _XR	10G	1

Note: A server supports up to three NICs of the same type, three 1 G/10 G NICs of different types, or only one 100 G (or above) NIC. It also supports mixed use of NICs of different types.

7.8 HCA Card

Table 7-13 HCA Card

Model & Description	Speed	Interfaces
MCX653105A-ECAT PCIe 3.0/4.0 x16 Single Port	100 G	1
HCA Card_I_1-EDR4X25_100HFA016LS_PCIE	100 G	1
MCX653105A-HDAT PCIe 3.0/4.0 x16	200 G	1

Note: PCI-E x16 is required for a speed of over 100 G.

7.9 HBA Card

Table 7-14 HCA Card

Model & Description	Speed
HBA Card_QL_4R1_QLE2690-ISR-BK_FC16G_PCIE	16
HBA Card_QL_8R2_QLE2742-ISR-BK_FC32G_PCIE	32
HBA Card_QL_4R2_QLE2692-ISR-BK_FC16G_PCIE	16

7.10 Graphic Card

Table 7-15 Graphic Card

Type	Model & Description	Max. No.
GPU	GPU_NV_16GB_Tesla-T4_256b_P/GPU_NV_16G_Tesla-T4_256b_P_Special	2
	GPU_NV_24G_NVIDIA-A10_384b	2

Note: This graphic card is the PCIe x16 bus, and needs to be inserted into the Riser card slot of X16.

7.11 Power Supply

The hot-swap power supply adheres to Intel's CRPS standard, adopts general electrical and structural design, and supports 1+1 redundancy. A maximum of 2 PSUs are supported. The power supply supports tool-free installation and removal. Once inserted into a server, it is locked automatically. A CRPS power supply is 80 PLUS Platinum rated, and offers various output powers. You can select a power supply according to the actual configuration.

- The following rated 110 V - 230 VAC and 240 VDC power supplies, with 1+1 redundancy are supported

550 W Platinum power supply: 550 W (110 VAC), 550 W (230 VAC), 550 W (240 VDC for China)

800 W Platinum power supply: 800 W (110 VAC), 800 W (230 VAC), 800 W (240 VDC for China)

1300 W Platinum power supply: 1000 W (110 VAC), 1300 W (230 VAC), 1300 W (240 VDC for China)

800 W Titanium power supply: 800 W (110 VAC), 800 W (230 VAC), 800 W (240 VDC for China)

1300 W Titanium power supply: 1000 W (110 VAC), 1300 W (230 VAC), 1300 W (240 VDC for China)

Note: At a rated voltage of 110 VAC, a 1300 W power supply will be derated to 1000 W.

Input voltage range:

110 VAC - 230 VAC: 90 V - 264 V

240 VDC: 180 V - 320 V

- The following rated 336 VDC power supplies with 1+1 redundancy are supported

800 W 336 VDC power supply: 800 W (336 VDC)

1300 W 336 VDC power supply: 1300 W (336 VDC)

Input voltage range:

336 VDC: 260 V - 400 V

- The following rated -48 VDC power supplies with 1+1 redundancy are supported

800 W -48 VDC power supply: 800 W (-48 VDC)

1300 W -48 VDC power supply: 1300 W (-48 VDC)

Input voltage range:

-48 VDC: -40 V to -72 V

7.12 Operating System

Table 7-15 Operating Systems

OS Manufacturer	OS Version
Windows	Windows Server 2019
Red Hat	Red Hat Enterprise 7.9
	Red Hat Enterprise 8.2
	Red Hat Enterprise 8.3
SUSE	SUSE 12.5
	SUSE 15.2
Centos	Centos_7.9
	Centos_8.2
	Centos_8.3
VMWare ESXI	Vmware Esxi_7.0U1

	Vmware Esxi_7.0
Ubuntu 16	Ubuntu 18.04
	Ubuntu 20.04

8 Configuration Notes

- Onboard and RAID cards cannot be used together.
- RAID/SAS cards with different chip models cannot be selected at the same time.
- The 32E1.S slide rail with CMA supports only cabinet with a length of 1.2 meters or above, without CMA can support length below 1.2 meter.

9 System Management

9.1 Intelligent Management System ISBMC

ISBMC is a remote management system for servers independently developed by Inspur, which supports industry mainstream management standards such as IPMI 2.0 and Redfish 1.8. ISBMC features high operational reliability, easy maintenance for customer scenarios, accurate and comprehensive fault diagnosis capabilities, and industry-leading security reinforcement capabilities.

ISBMC has the following features:

- Supports IPMI 2.0
- Supports Redfish 1.8
- Supports simple network management protocols (SNMP v1/v2c/v3)
- Supports HTML5/Java remote consoles (keyboards, mice, and videos)
- Supports remote virtual media
- Supports login on web browsers
- Supports intelligent fault diagnosis

Table 9-1 ISBMC Specifications

Specification	Description
Management Interface	Supports extensive remote management interfaces and is applicable to various server O&M scenarios. The supported interfaces include: <ul style="list-style-type: none"> ● IPMI ● SSH CLI ● SNMP ● HTTPS ● Web GUI ● Redfish ● Restful ● DCMi ● Syslog
Intelligent Fault Location	With IDL, a fault diagnosis system independently developed by Inspur, it provides comprehensive and accurate hardware fault location capabilities, and outputs detailed fault causes and correction suggestions.
Alarm Management	Supports rich automatic remote alarm capabilities, including SNMP Trap (v1/v2c/v3), email alarms, syslog remote alarms, and other proactive alarming mechanisms to ensure 24 × 7 device reliability.

Remote Console KVM	Supports HTML5- and Java-based remote consoles, supports remotely taking over the display/mouse/keyboard of the server, and provides highly available remote management capabilities without on-site operations.
Virtual Network Console (VNC)	Supports mainstream third-party VNC clients without relying on Java and improves management flexibility.
Remote Virtual Media	Supports virtualizing local media devices or mirrors, USB devices, and folders as media devices of remote servers, simplifying system installation, file sharing, and other O&M tasks.
Web GUI	Supports the visual management interface developed by Inspur, provides comprehensive display of server information and status, and offers an easy-to-use O&M panel.
Downtime Screenshotting and Common Screenshotting	Supports automatic screenshotting during downtime to capture the last screen before the downtime, and provides the screenshotting function, which can quickly capture the screen to facilitate regular inspections.
Dual Flash and Dual Mirroring	Supports dual flash and dual mirroring with automatic flash failover upon software faults or flash damage, improving operational reliability.
Power Capping	Supports power capping, increasing deployment density and reducing energy consumption.
IPv4/IPv6	Supports both IPv4 and IPv6, enhancing network deployment flexibility.
Adaptation of Management Network Interfaces	Supports adaptation of dedicated management network interfaces and network controller sideband interfaces (NC-SIs), and provides customers with flexible network deployment solutions for different management network deployment scenarios.
ISBMC Self-diagnosis and Self-recovery System	Supports the reliable dual watchdog mechanism for hardware and software, enabling automatic restoration of abnormal programs to normal under extreme BMC situations. Provides a heat dissipation protection mechanism, which is automatically triggered when a BMC program is abnormal to ensure that the fan operates at a safe speed to avoid overheating of the entire system. Supports self-diagnosis of processors, memory modules, and storage devices of ISBMC, and automatically cleans up the workload and restores to normal when the device consumption rate is too high.
Power Supply Control	Supports virtual power buttons for startup, shutdown, restart, and shutdown and then restart.
UID LED and Remote Control LED	Supports remote lighting of the unit identification (UID) LED for locating the server in the server room, and supports remote control LED. The UID LED flashes when a user remotely logs in through the web, KVM, or SSH to inform the on-site personnel that an administrator is accessing the server.
Secure Firmware Upgrade	Supports firmware upgrades based on secure digital signatures, unexpected upgrade prevention mechanism for different manufacturers and models, and firmware upgrades of BMC/BIOS/CPLD/PSU and other devices.
Serial Port	Supports remote redirection of system serial ports, BMC serial

Redirection	ports, and other serial ports, and directs the server-side serial port output to the local administrator through the network for server debugging.
Storage Information Viewing	Supports display of Raid logical array information and drive information, and remote RAID formation for improved deployment efficiency.
User Role Management	Supports refined user management based on user roles and flexible creation of user roles with different permissions, and provides refined user roles to allow administrators to grant different permissions to O&M personnel.
Security Features	Adopts the industry-leading Inspur server security baseline standard V2.0, and uses secure and reliable algorithms for SSH, HTTPS, SNMP, and IPMI, and has the capabilities including secure upgrade and boot as well as security reinforcement mechanisms such as anti-replay, anti-injection, and anti-brute force.

9.2 Inspur Physical Infrastructure Manager (ISPIM)

The NF5180M6 server is compatible with the latest version of Inspur Physical Infrastructure Manager (ISPIM).

ISPIM is a next-generation infrastructure O&M management platform for industry data centers. Based on cutting-edge O&M concepts, ISPIM provides users with leading and efficient overall management solutions for data centers to ensure the advancement of their infrastructure management. This platform provides a rich set of functions such as centralized resource management, in-depth fault diagnosis, real-time performance monitoring, intelligent energy consumption management, 3D automatic topology, and stateless automatic deployment. With these functions, users can implement central O&M of servers, storage devices, network devices, security devices, and edge devices, effectively improving O&M efficiency, reducing O&M costs, and ensuring the secure, reliable, and stable operation of data centers. ISPIM has the following key features:

- Lightweight deployment for multiple scenarios and full lifecycle management of devices
- High reliability and on-demand node expansion for 1-N data collection
- Intelligent asset management and real-time tracking of asset changes
- Comprehensive monitoring for overall business control
- Intelligent fault diagnosis for reduced correction time
- Real-time performance monitoring for real-time status control of devices
- Batch upgrade, configuration, and deployment for reduced launch time
- Version management for improved version management efficiency
- Standardized northbound interfaces for easy integration and interfacing

Table 9-2 ISPIM Specifications

Specification	Description
Centralized Device Management	Supports centralized management of network-wide devices, including servers (covering the complete Inspur server family, including general rack-mounted servers, AI servers, blade servers, all-in-ones and other high-end server products, and third-party servers), storage devices (Inspur general disk arrays, distributed storage devices, and storage devices of other manufacturers), and network devices (Inspur switches, third-party switches, and third-party firewall devices).
Monitoring Management	Supports centralized display, search, and blocking of device alarms, and email notifications, and supports the creation of alarm rules, notification rules, and blocking rules, alarm redefinition, alarm forwarding and southbound settings, device performance monitoring, and distributed monitoring.
Stateless Computing	Supports BMC/BIOS upgrade and configuration of Inspur servers, RAID configuration of Inspur servers, automatic hardware baseline management, and file repository upgrade.
Operating System Deployment	Supports batch deployment of operating systems through the BMC interface, one-click deployment with automatic status writeback without manual intervention, and concurrent deployment of up to 40 devices.
Asset Management	Supports part-level asset management, multi-dimensional asset statistics, 3D data centers, and asset maintenance management.
Inspection Management	Supports active inspection tasks, alarm-triggered passive inspection, intelligent fault diagnosis and analysis, and automatic fault reporting and correction.
Security Management	Implements security control of ISPIM by using a set of security policies such as user management, role management, authentication management (local authentication and LDAP authentication), and certificate management policies.

9.3 Inspur Server Intelligent Boot (ISIB)

NF5180M6 is compatible with the latest version of Inspur Server Intelligent Boot (ISIB) system, which is a full lifecycle automatic O&M management system for servers independently developed by Inspur. Based on the SSH and PXE technologies, it is compatible with the entire family of Inspur servers, and has more efficient and reliable automatic deployment and software and hardware configuration management functions. ISIB has the following key features:

- Full lifecycle device management from racking to automatic O&M
- Bare-metal one-stop deployment with one-click racking
- Flexible task scheduling with multi-scenario O&M capabilities
- Large-scale deployment of technical architecture for reduced launch time
- Zero network deployment with plug-and-play support
- Accurate logging and instruction-level tracing of execution results















- Rich built-in O&M scripts and management schemes

Table 9-3 ISIB Specifications

Specification	Description
Home	Provides multi-dimensional statistical results of assets, repositories, operations, and jobs, dynamic display of jobs in the last 24 hours, and histogram display of jobs in the last 30 days.
Asset	Supports automatic device discovery, operating system information collection, and out-of-band/in-band power supply management.
Repository	Provides the management of mirrors, software, firmware, configuration files, scripts, and sources to facilitate operations such as operating system deployment and firmware upgrades.
Operation	Supports firmware upgrades; Supports hardware configuration; Supports PXE automatic installation; Supports installation template management; Supports mirror cloning and restoration; Supports software distribution; Supports configuration changes; Supports system inspection.
Task	Supports job scheduling, and scheduled and periodic task execution. Provides visual multi-dimensional task display and refined log viewing.
GShell	Supports remote management of a single SSH terminal or multiple SSH terminals.

10 Certification

Parts of the task book to be certified:

Region	Certification Program	Certification Logo	Mandatory/Voluntary
China	CCC		Mandatory
	CECP		Voluntary
	China Environmental Labelling		Voluntary
International	CB	N/A	Voluntary
EN	CE		Mandatory
U.S.	FCC		Mandatory
	UL		Voluntary
	Energy Star		Voluntary
Russia	EAC		Mandatory
	FSS	N/A	Mandatory
India	BIS		Mandatory
Korea	E-Standby		Mandatory
	KC		Mandatory
Australia	RCM		Mandatory
Israel	SII		Mandatory
Mexico	NOM		Mandatory

11 Support and Services

Please visit the official website of Inspur at <https://en.inspur.com/>, click **Support > Support Center > Warranty & Configuration**, and enter the product model, part model, serial number or keywords to learn relevant information and check the warranty status and configuration of related product.

Global service hotline:

- 1-844-860-0011 (toll free)
- 1-760-769-1847 (direct line)
- Service email: serversupport@inspur.com

Information required from customers:

- Name
- Organization info
- Contact number
- Email
- Product model
- Product SN
- Problem description

12 Relevant Documents

For more information, visit this link:

<http://en.inspur.com>

The website provides some resources to help customers solve problems and learn about our products, such as product manuals, drivers, and firmware.

13 Trademark

Inspur and Inspur logos are owned by Inspur Group Co., Ltd. All other trademarks and trade names mentioned in this document are the properties of their respective owners.